

SCADENZA 31 DICEMBRE 2024



www.gerardi.it

10 - 14 / 09 / 2024  
Hall 3 - Booth 3b62

9 - 12 / 10 / 2024  
Pad 11 - Stand D18



ITALIANO

# OFFERTA SPECIALE

**ZERO POINT**  
Il primo passo verso  
l'automazione



**NEW**  
**2024**

NOVITÀ 2024! RICHIEDI MAGGIORI INFORMAZIONI

## PIANI MAGNETICI

**Ideale per operazioni di fresatura e non solo!**

- Completa eliminazione di vibrazioni durante la lavorazione
- Migliora il grado di finitura e riduce il consumo degli utensili
- Resistenza a stress e deformazioni e posizionamento preciso dei pezzi da lavorare



Vai alla Brochure

# Morse COMPACT GRIP

Morsa autocentrante con ganasce reversibili - Ideale per centri a 5 assi

## Art.650



Dot. standard: 1 chiave a pipa Art.375, 1 arresto laterale Art.370EM, 1 coppia di tasselli per regolazione autocentrante Art. 297, 2 tasselli di posizionamento Art.650G cava a T 16 mm, 1 Art. 650F piastra di bloccaggio slitta

**+** Arresto laterale magnetico Art. 370EM

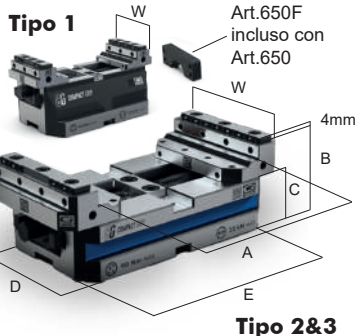

Tipo	Larghezza ganascia W	Apertura massima A	Altezza morsa B	Altezza corpo C	Larghezza base D	Lunghezza base E	Kg	Cod.	PREZZO LISTINO €	PREZZO OFFERTA €
1 12kN	50	54	65	45	79,9	80	1,9	7.65.01080	<del>777</del>	<b>649</b>
		94				120		7.65.01120	<del>897</del>	<b>749</b>
		134				160		7.65.01160	<del>1.015</del>	<b>849</b>
2 22kN	88	96	65	38	89,9	120	3,6	7.65.02120	<del>955</del>	<b>749</b>
		136				160		7.65.02160	<del>1.075</del>	<b>849</b>
		176				200		7.65.02200	<del>1.194</del>	<b>949</b>
		216				240		7.65.02240	<del>1.314</del>	<b>1.049</b>
		133				160		7.65.03160	<del>1.552</del>	<b>1.149</b>
3 32kN	123	183	89	57	124,9	210	10,9	7.65.03210	<del>1.790</del>	<b>1.249</b>
		233				260		7.65.03260	<del>2.029</del>	<b>1.349</b>
		283				310		7.65.03310	<del>2.387</del>	<b>1.649</b>
		333				360		7.65.03360	<del>2.625</del>	<b>1.849</b>

## MAXIGRIP

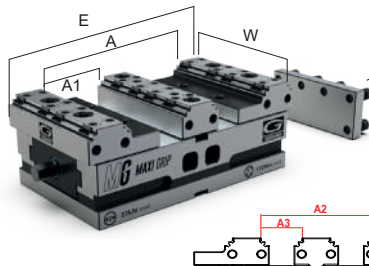

### Art.685

Morsa MaxiGrip - 3 Serraggi in 1 - Autocentrante, doppia e singola

Tipo	kN	A	A1	A2	A3	W	E	Kg	Cod.	PREZZO LISTINO €	PREZZO OFFERTA €
4x270	41	200	83	104	35	158	270	28,5	76854270	<del>2.920</del>	<b>2.299</b>
4x420		344	155	248	107		420		40	76854420	<del>3.870</del>

### Art.684

Morsa MaxiGrip - Solo Autocentrante

Tipo	kN	A	A1	A2	A3	W	E	Kg	Cod.	PREZZO LISTINO €	PREZZO OFFERTA €
4x270	41	200	-	104	-	158	270	25	76844270	<del>2.500</del>	<b>1.999</b>
4x420		344	-	248	-		420		36	76844420	<del>3.450</del>

## RIALZI PER MORSE COMPACT GRIP

### Art.651H

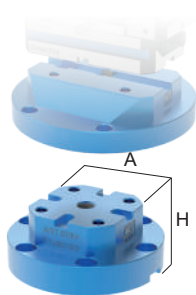

Tipo	Ingombro base A	H=50			H=75			H=100		
		Cod.	PREZZO LISTINO €	PREZZO OFFERTA €	Cod.	PREZZO LISTINO €	PREZZO OFFERTA €	Cod.	PREZZO LISTINO €	PREZZO OFFERTA €
1	80	7.65.1H1080/050	<del>414</del>	<b>350</b>	7.65.1H1080/075	<del>425</del>	<b>350</b>	7.65.1H1080/100	<del>437</del>	<b>350</b>
	120	7.65.1H1120/050	<del>492</del>	<b>400</b>	7.65.1H1120/075	<del>517</del>	<b>400</b>	7.65.1H1120/100	<del>539</del>	<b>400</b>
	160	7.65.1H1160/050	<del>588</del>	<b>450</b>	7.65.1H1160/075	<del>620</del>	<b>500</b>	7.65.1H1160/100	<del>654</del>	<b>500</b>
2	120	7.65.1H2120/050	<del>588</del>	<b>450</b>	7.65.1H2120/075	<del>620</del>	<b>500</b>	7.65.1H2120/100	<del>654</del>	<b>500</b>
	160	7.65.1H2160/050	<del>588</del>	<b>500</b>	7.65.1H2160/075	<del>620</del>	<b>550</b>	7.65.1H2160/100	<del>654</del>	<b>550</b>
	200	7.65.1H2200/050	<del>588</del>	<b>550</b>	7.65.1H2200/075	<del>620</del>	<b>600</b>	7.65.1H2200/100	<del>654</del>	<b>600</b>
3	240	7.65.1H2240/050	<del>727</del>	<b>600</b>	7.65.1H2240/075	<del>773</del>	<b>600</b>	7.65.1H2240/100	<del>820</del>	<b>650</b>
	160	7.65.1H3160/050	<del>680</del>	<b>650</b>	7.65.1H3160/075	<del>726</del>	<b>650</b>	7.65.1H3160/100	<del>769</del>	<b>650</b>
	210	7.65.1H3210/050	<del>680</del>	<b>650</b>	7.65.1H3210/075	<del>726</del>	<b>700</b>	7.65.1H3210/100	<del>769</del>	<b>700</b>
	260	7.65.1H3260/050	<del>1.047</del>	<b>950</b>	7.65.1H3260/075	<del>1.106</del>	<b>950</b>	7.65.1H3260/100	<del>1.167</del>	<b>950</b>
	310	7.65.1H3310/050	<del>1.085</del>	<b>1.000</b>	7.65.1H3310/075	<del>1.146</del>	<b>1.000</b>	7.65.1H3310/100	<del>1.207</del>	<b>1.000</b>
	360	7.65.1H3360/050	<del>1.255</del>	<b>1.100</b>	7.65.1H3360/075	<del>1.326</del>	<b>1.100</b>	7.65.1H3360/100	<del>1.398</del>	<b>1.100</b>

## SUPPORTO PIRAMIDALE SPECIFICO PER CENTRI DI LAVORO A 5 ASSI - MORSE INCLUSE

### Art.643H



Supporto piramidale in alluminio, consente di montare contemporaneamente 3 morse Compact Grip con o senza piastre inclinate di 45° o 60° incrementando così lo spazio di lavoro e permettendo lavorazioni anche di più particolari contemporaneamente anche in punti normalmente difficili da raggiungere.

Type	Altezza	Cod.	PREZZO LISTINO €
1 (Ø200)	170	7.64.3H100	1.763
2 (Ø308)	136	7.64.3H200	2.157
3 (Ø360)	190	7.64.3H300	2.314

Dotazione standard: 12 Staffe di ancoraggio Art.298 CGR, 1 Golfare, 1 Perno di centraggio, Coppia di tasselli Art.297

**+** MONTAGGIO & ALLINEAMENTO INCLUSO

### KIT 1

Art. 643H + N°3 Art.650 T.1x120



Cod.	PREZZO LISTINO €	PREZZO OFFERTA €
6501120-G11-643H1-60	4.373	<b>3.400</b>

### KIT 2

Art. 643H + N°3 Art.650 T.2x200



Cod.	PREZZO LISTINO €	PREZZO OFFERTA €
6502200-G11-643H2-30/45	5.571	<b>4.200</b>

### KIT 3

Art. 643H + N°3 Art.650 T.3x210



Cod.	PREZZO LISTINO €	PREZZO OFFERTA €
6503210-G11-643H3-45	7.525	<b>5.300</b>



# Piastre a CAMBIO RAPIDO

Piastre a cambio rapido meccanico per morse compact grip - Ideali per centri a 5 assi

## Art.660

Piastra cambio rapido rettangolare

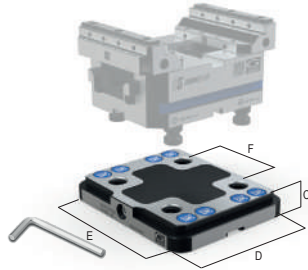

Dotazione standard: 4 Tiranti Art.660B

Tipo	C	D	E	Kg	Cod.	PREZZO LISTINO €	PREZZO OFFERTA €
1-2 (F=52)	27	116	150	3	9.66.05200	787	599
3 (F=96)	27	156	190	5,2	9.66.09600	1.133	899

## Art.661

Piastra cambio rapido tonda

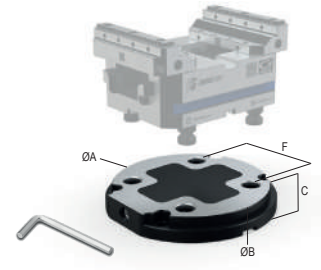

Dotazione standard: 4 Tiranti Art.660B

Tipo	ØA	ØB	C	Kg	Cod.	PREZZO LISTINO €	PREZZO OFFERTA €
1-2 (F=52)	156	120	27	3	9.66.15200	754	599
3 (F=96)	196	175	27	5,2	9.66.19600	1.102	899

## Art.660S

Piastra cambio rapido rettangolare temprata con parte lavorabile senza fori

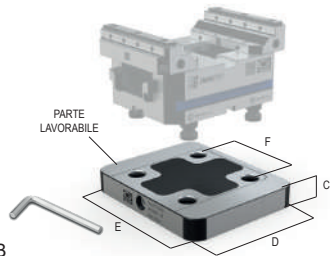

Personalizzazione esclusa

Dotazione standard: 4 Tiranti Art.660B

Tipo	C	D	E	Kg	Cod.	PREZZO LISTINO €	PREZZO OFFERTA €
1-2 (F=52)	27	126	150	3	9.66.0S520	638	499
3 (F=96)	27	156	190	5,2	9.66.0S960	870	699

## Art.661S

ANCHE CON PASSAGGIO BARRA

Piastra cambio rapido tonda temprata con parte lavorabile senza fori

Disponibili modelli per qualsiasi piastra girevole o 4° asse

Personalizzazione esclusa

Dotazione standard: 4 Tiranti Art.660B

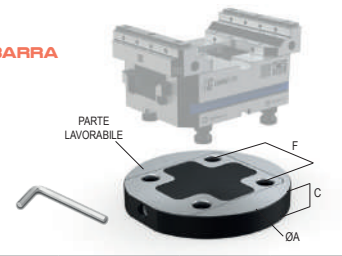

Tipo	ØA	C	Kg	Cod.	PREZZO LISTINO €	PREZZO OFFERTA €
1-2 (F=52)	156	27	3,8	9.66.1S5200	696	499
	196	27	6	9.66.1S9600	1.159	699
3 (F=96)	250	24	10	9.66.1S960-250	1.647	1.500
	300	24	15	9.66.1S960-300	1.750	1.600

## Art.660R

Riduzione rettangolare

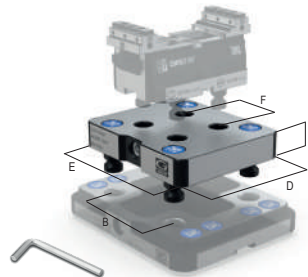

Dotazione standard: 4 Tiranti Art.660B

Tipo	B	C	D	E	Kg	Cod.	PREZZO LISTINO €	PREZZO OFFERTA €
F = 52	96	27	126	150	3,75	9.66.0R210	696	499

## Art.661R

Riduzione tonda

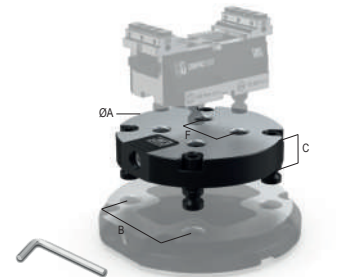

Dotazione standard: 4 Tiranti Art.660B

Tipo	A	B	C	Kg	Cod.	PREZZO LISTINO €	PREZZO OFFERTA €
F = 52	158	96	27	3,75	9.66.1R210	870	499

## Art.660B

Tiranti per piastra a cambio rapido



Per piastre di tipo 1-2

Per piastre di tipo 3

Tipo	Cod.	PREZZO LISTINO CAD. €
1 - 2	9.66.0B100	31
3	9.66.0B200	33

## Art.661H

Rialzo base in alluminio per piastra cambio rapido, possibilità di montaggio con staffe o tramite Zero Point



## Art.661S

ANCHE CON PASSAGGIO BARRA

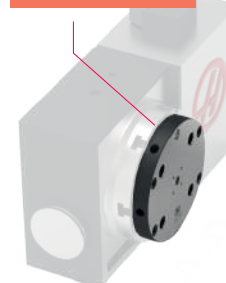

Piastra girevole Haas Hrt200

Tiranti Art.660B

Autocentrante



Piastra interfaccia Art.62B



ESEMPIO di montaggio piastra a cambio rapido tonda per morse CompactGrip

Morsa CompactGrip Art.650 T.3

# Morse STANDARD FLEX

Geniale sistema a pettine per la rapida sostituzione delle piastre ganasce - Ideale per centri verticali

## Art.1A

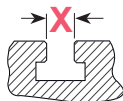

Dot. standard: 1 Arresto laterale, 2 tasselli di posizionamento per cava 16mm, 2 Tappi, 1 Chiave a pipa, 1 Chiave a "T"

**+ 4 Staffe Art.298**

Morsa modulare di precisione serie StandardFLEX

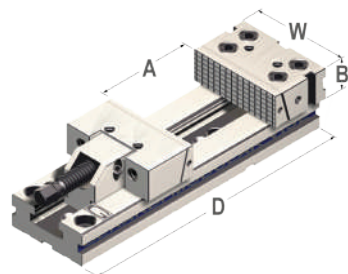

Tipo	Apertura massima A	Larghezza ganasce W	Altezza ganasce B	Lunghezza base D	Cod.	PREZZO LISTINO €	PREZZO OFFERTA €
2 25kN	150	121 mm	38	345	1.1A.20000	925	789
	200			420	1.1A.32000	1.112	839
3 30kN	300	146 mm	48	520	1.1A.33000	1.283	949
	200			455	1.1A.42000	1.414	1.189
4 30kN	300	171 mm	58	555	1.1A.43000	1.555	1.239
	400			655	1.1A.44000	1.696	1.339
5 40kN	200	196 mm	63	495	1.1A.52000	1.846	1.489
	300			595	1.1A.53000	2.210	1.789
	400			695	1.1A.54000	2.582	2.039

**RISPARMI IL 20%**

\* Solo se acquistate con la morsa



# Morse EXTRA LUNGHE

Le morse XL hanno la base molto più lunga delle normali morse standard - Ideali per centri verticali

## Art.21

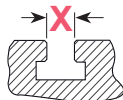

Dot. standard: 1 Arresto laterale, 2 tasselli di posizionamento per cava 16mm, 1 Chiave a pipa, 1 Chiave a "T"

**+ 6 Staffe Art.298**

Morsa serie XL con dotazione standard

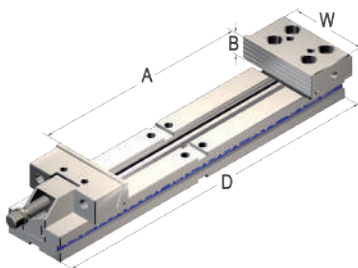

Tipo	Apertura massima A	Larghezza ganasce W	Altezza ganasce B	Lunghezza base D	Kg	Cod.	PREZZO LISTINO €	PREZZO OFFERTA €
2 25kN	320	125 mm	40	520	17	2.21.23200	1.147	800
	360			580	32	2.21.33600	1.425	1.000
3 30kN	460	150 mm	50	680	35	2.21.34600	1.578	1.150
	500			766	52	2.21.45000	1.828	1.350
4 30kN	600	175 mm	60	866	56	2.21.46000	1.990	1.450
	700			966	61	2.21.47000	2.159	1.550

**RISPARMI IL 20%**

\* Solo se acquistate con la morsa

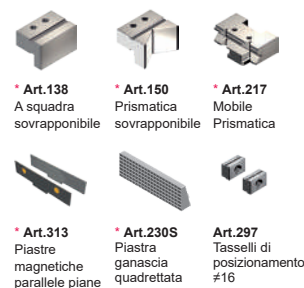

# Parallele MAGNETICHE

Ampia gamma di altezze disponibili a pag.4.27 - Listino generale w17

**RISPARMI FINO AL 40%**

PER MORSE STANDARD & STANDARDFLEX ART.1 E ART.1A

## Art.310

## Art.311

Coppia di parallele magnetiche guidate

Prezzo Cad. se acquistate con set **6** coppie di parallele (Art.313-313R)

Prezzo Cad. se acquistate con set **10** coppie di parallele (Art.313-313R)

Tipo	PREZZO LISTINO €	PREZZO CAD €	PREZZO KIT €	PREZZO CAD €	PREZZO KIT €
1	73	50	300	-	-
2	93	65	390	-	-
3	116	75	450	70	700
4	136	90	540	80	800
5	155	100	600	90	900
6	176	120	720	100	1.000

Spessore:  
**2,8mm**

## Art.414

Disponibili anche Parallele Magnetiche Universali



# Kit di AUTOMAZIONE

Centraline con comando pneumatico e cilindro a singolo effetto - Ideale per centri verticali

PER MORSE STANDARD & STANDARDFLEX ART.1 E ART.1A

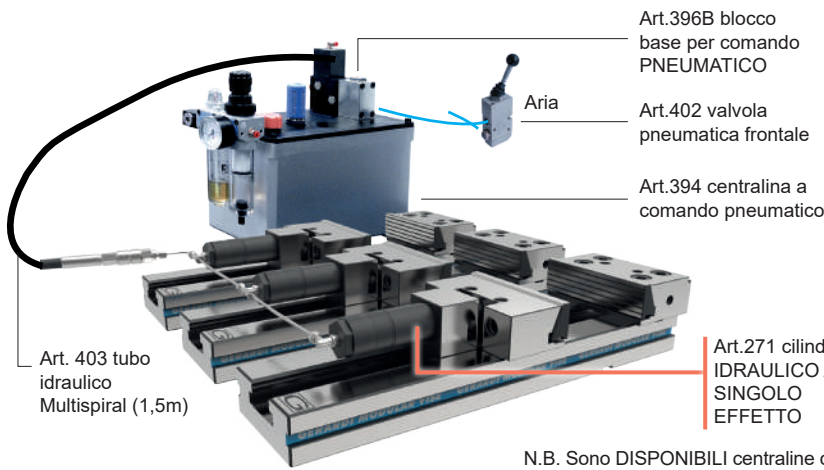

Art.396B blocco base per comando PNEUMATICO

Aria

Art.402 valvola pneumatica frontale

Art.394 centralina a comando pneumatico

Art. 403 tubo idraulico Multispiral (1,5m)

Art.271 cilindro IDRAULICO A SINGOLO EFFETTO

N.B. Sono DISPONIBILI centraline con elettrovalvole per PER CNC

**MORSA NON INCLUSA**

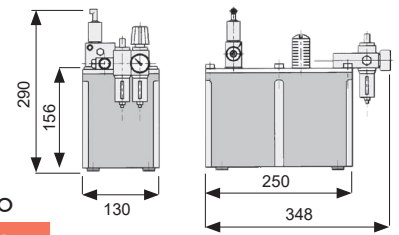

N°1 SERRAGGIO

**Art.392**

Tipo	Corsa Pistone Art.271	Cod.	PREZZO LISTINO €	PREZZO OFFERTA €
2	26	4.39.22000	1.872	<b>1.499</b>
3		4.39.23000	1.884	<b>1.499</b>
4	40	4.39.24000	1.917	<b>1.499</b>
5		4.39.25000	2.109	<b>1.599</b>

## KIT DI SERRAGGIO SIMULTANEO DI PIÙ MORSE

**Art.392/2**

(Art.271- 394 - 402 - 403)  
N°2 SERRAGGI SIMULTANEI  
Art.392 + N°1 Art.271

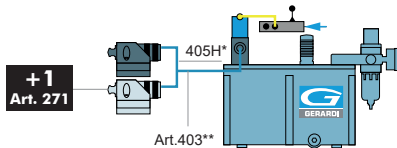

Tipo	Cod.	PREZZO LISTINO €	PREZZO OFFERTA €
2	4.39.22002	2.255	<b>1.799</b>
3	4.39.23002	2.277	<b>1.799</b>
4	4.39.24002	2.345	<b>1.799</b>
5	4.39.25002	2.725	<b>2.099</b>

**Art.392/3**

N°3 SERRAGGI SIMULTANEI  
Art.392 + N°2 Art.271

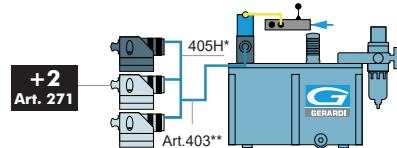

Tipo	Cod.	PREZZO LISTINO €	PREZZO OFFERTA €
2	4.39.22003	2.634	<b>2.099</b>
3	4.39.23003	2.667	<b>2.099</b>
4	4.39.24003	2.767	<b>2.099</b>
5	4.39.25003	3.341	<b>2.499</b>

**Art.392/4**

N°4 SERRAGGI SIMULTANEI  
Art.392 + N°3 Art.271

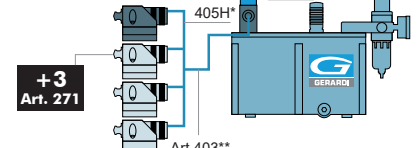

Tipo	Cod.	PREZZO LISTINO €	PREZZO OFFERTA €
2	4.39.22004	3.017	<b>2.399</b>
3	4.39.23004	3.059	<b>2.399</b>
4	4.39.24004	3.196	<b>2.399</b>
5	4.39.25004	3.958	<b>2.999</b>

\*Art.405H Tubo in acciaio zincato Ø6 (m1,0)  
(Non compreso) Codice: 4.40.5H000

## KIT DI SERRAGGIO INDIPENDENTE DI PIÙ MORSE

**Art.392A/2**

(Art.271- 394 - 402 - 403)  
N°2 SERRAGGI INDIPENDENTI  
Art.392 + N°1 Art.407B

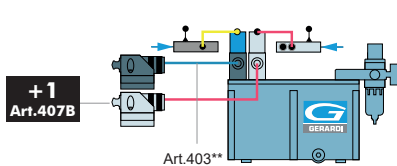

Tipo	Cod.	PREZZO LISTINO €	PREZZO OFFERTA €
2	4.39.2A202	3.063	<b>2.399</b>
3	4.39.2A302	3.083	<b>2.399</b>
4	4.39.2A402	3.161	<b>2.399</b>
5	4.39.2A502	3.639	<b>2.799</b>

**Art.392A/3**

N°3 SERRAGGI INDIPENDENTI  
Art.392 + N°2 Art.407B

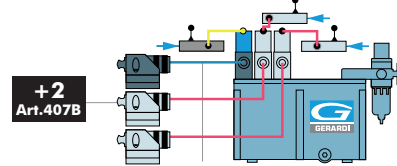

Tipo	Cod.	PREZZO LISTINO €	PREZZO OFFERTA €
2	4.39.2A203	3.564	<b>2.799</b>
3	4.39.2A303	3.596	<b>2.799</b>
4	4.39.2A403	3.695	<b>2.799</b>
5	4.39.2A503	4.247	<b>3.299</b>

**Art.392A/4**

N°4 SERRAGGI INDIPENDENTI  
Art.392 + N°3 Art.407B

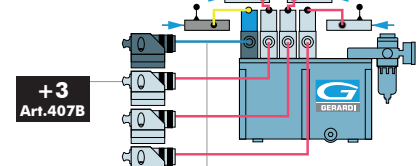

Tipo	Cod.	PREZZO LISTINO €	PREZZO OFFERTA €
2	4.39.2A204	4.413	<b>3.599</b>
3	4.39.2A304	4.455	<b>3.599</b>
4	4.39.2A404	4.584	<b>3.599</b>
5	4.39.2A504	5.319	<b>4.199</b>

\*Art.403 (Compresso) Tubo idraulico Multispiral 760bar completo di attacco rapido Art. 270A (m 1,5) Codice: 4.40.30000

# Morse FMS

Per serraggi singoli, doppi e autocentranti - Ideali per centri verticali e ed orizzontali

**Art.855**

Corpo Base 3 in 1



**Art.855A**

Corpo Base  
Solo Autocentrante

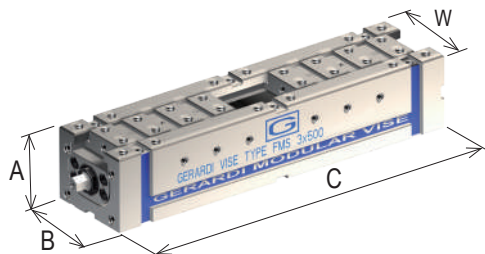

Tipo W	Altezza base A	Larghezza base B	Lunghezza base C	Art.855		Art.855A	
				Cod.	PREZZO LISTINO €	Cod.	PREZZO LISTINO €
2 (94mm) 25kN	90	95	400	5.85.52400	1.365	5.85.5240A	1.447
			500	5.85.52500	1.848	5.85.5250A	1.947
			600	5.85.52600	2.041	5.85.5260A	2.114
3 (124mm) 30kN	100	125	500	5.85.53500	1.773	5.85.5350A	1.864
			600	5.85.53600	2.452	5.85.5360A	2.559
4 (144mm) 30kN	120	145	600	5.85.54600	2.258	5.85.5460A	2.337

## COMPONI LA TUA MORSA CON LE CENTINAIA DI GANASCE DISPONIBILI

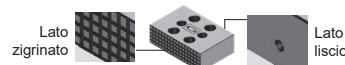

### PER SERRAGGI DOPPI ED AUTOCENTRANTI

**Art.860**

Morsa doppia con ganasce zigrinate.

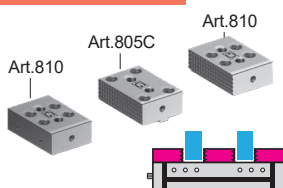

Tipo	Cod.	PREZZO LISTINO €	PREZZO OFFERTA €
2	5.86.02400	1.794	1.400
	5.86.02500	2.281	1.800
	5.86.02600	2.471	1.950
	5.86.03500	2.264	1.800
3	5.86.03600	2.941	2.300
	5.86.04600	2.908	2.300

**Art.863**

Morsa doppia con ganasce a gradino

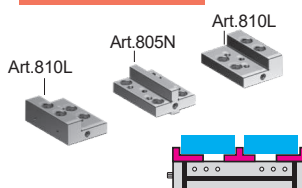

Tipo	Cod.	PREZZO LISTINO €	PREZZO OFFERTA €
2	5.86.32400	1.952	1.550
	5.86.32500	2.436	1.900
	5.86.32600	2.628	2.100
	5.86.33500	2.420	1.900
3	5.86.33600	3.098	2.450
	5.86.34600	3.104	2.450

**Art.865**

Morsa doppia con ganasce a cambio rapido discendente (sistema a pettine)

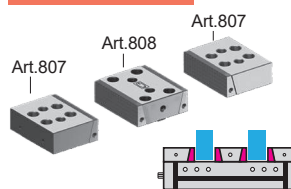

Tipo	Cod.	PREZZO LISTINO €	PREZZO OFFERTA €
2	5.86.52400	2.120	1.700
	5.86.52500	2.604	2.100
	5.86.52600	2.798	2.200
	5.86.53500	2.735	2.200
3	5.86.53600	3.418	2.700
	5.86.54600	3.540	2.800

**Art.866**

Morsa doppia con ganasce oscillanti a gradino (3x5)

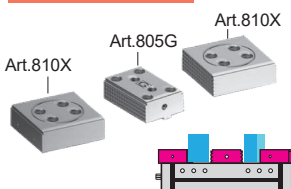

Tipo	Cod.	PREZZO LISTINO €	PREZZO OFFERTA €
2	5.86.62400	2.242	1.800
	5.86.62500	2.728	2.200
	5.86.62600	2.918	2.300
	5.86.63500	2.761	2.200
3	5.86.63600	3.439	2.700
	5.86.64600	3.391	2.700

**Art.867**

Morsa doppia con ganasce oscillanti con inserti regolabili

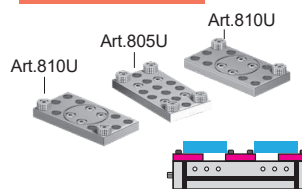

Tipo	Cod.	PREZZO LISTINO €	PREZZO OFFERTA €
2	5.86.72400	2.618	1.999
	5.86.72500	3.048	2.328
	5.86.72600	3.293	2.516
	5.86.73500	3.171	2.423
3	5.86.73600	3.850	2.941
	5.86.74600	3.874	2.960

### \* SOLO AUTOCENTRANTI

\* Per morsa SOLO autocentrante, distanziale Art.850T incluso nel prezzo

**Art.855A**

Corpo Base -  
Solo Autocentrante

**Art.860A**



**Art.810**

2 Ganasce Zigrinate

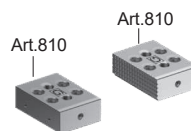

Tipo	* PREZZO LISTINO €
2	1.647
	2.135
	2.325
	2.100
3	2.776
	2.682

**Art.855A**

Corpo Base -  
Solo Autocentrante

**Art.863A**



**Art.810L**

2 Ganasce a gradino

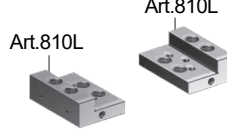

Tipo	* PREZZO LISTINO €
2	1.722
	2.206
	2.398
	2.172
3	2.848
	2.775

**Art.855A**

Corpo Base -  
Solo Autocentrante

**Art.865A**



**Art.807**

2 Ganasce a cambio rapido discendente

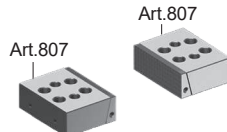

Tipo	* PREZZO LISTINO €
2	1.846
	2.330
	2.524
	2.332
3	3.015
	3.008

**Art.855A**

Corpo Base -  
Solo Autocentrante

**Art.868A**

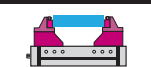

**Art.814** (n2)

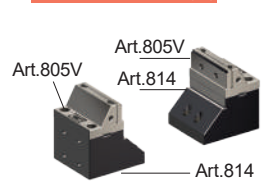

**Art.805V** (n2)

Tipo	* PREZZO LISTINO €
2	2.113
	2.578
	2.757
	2.590
3	3.246
	3.328

**Art.855A**

Corpo Base -  
Solo Autocentrante

**Art.870A**

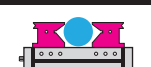

**Art.810J**

2 Ganasce prismatiche

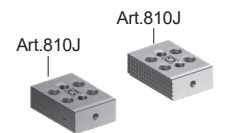

Tipo	* PREZZO LISTINO €
2	1.882
	2.367
	2.558
	2.377
3	3.054
	3.108

# Morse MULTIFLEX

Possono serrare fino a 19 particolari di dimensioni diverse - Ideali per centri verticali e ed orizzontali



Dot. standard: Chiave a "T", 2 tasselli di posizionamento e 4 arresti laterali. Ogni morsa è predisposta per il serraggio di 4 pezzi.

**+ COMPRESO** : 6 Staffe Art.298

(\* Modelli predisposti per serrare 3 particolari)

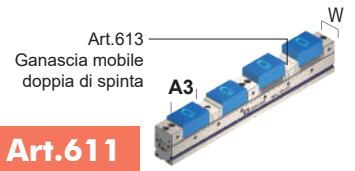
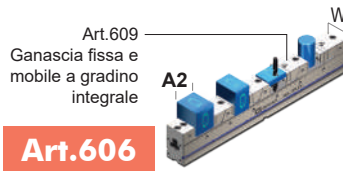
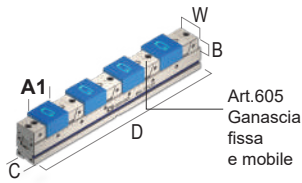

**Art.600**

**Art.600W**

**Art.606**

**Art.611**

Tipo	B	C <sup>+0,002</sup>	D	W	A1 mm	Cod.	PREZZO LISTINO €	PREZZO OFFERTA €	A2 mm	Cod.	PREZZO LISTINO €	PREZZO OFFERTA €	A3 mm	Cod.	PREZZO LISTINO €	PREZZO OFFERTA €
1 20kN	32/25	50	49	300	4x8	6.60.01300	1.204	<b>749</b>	* 3x19	6.60.61300	1.822	<b>1.200</b>	* 3x21	6.61.11300	1.822	<b>1.200</b>
				400	4x33	6.60.01400	1.308	<b>849</b>	4x23	6.60.61400	1.898	<b>1.300</b>	4x46	6.61.11400	1.898	<b>1.300</b>
				500	4x58	6.60.01500	1.425	<b>949</b>	4x48	6.60.61500	2.013	<b>1.400</b>	4x71	6.61.11500	2.013	<b>1.400</b>
				600	4x83	6.60.01600	1.553	<b>1.049</b>	4x73	6.60.61600	2.141	<b>1.500</b>	4x96	6.61.11600	2.130	<b>1.500</b>
				700	4x108	6.60.01700	1.736	<b>1.149</b>	4x97	6.60.61700	2.327	<b>1.600</b>	4x121	6.61.11700	2.327	<b>1.600</b>
2 30kN	40	75	74	400	4x12	6.60.02400	1.566	<b>1.099</b>	* 3x28	6.60.62400	2.266	<b>1.550</b>	4x34	6.61.12400	2.266	<b>1.550</b>
				500	4x37	6.60.02500	1.681	<b>1.249</b>	4x24	6.60.62500	2.386	<b>1.650</b>	4x59	6.61.12500	2.386	<b>1.650</b>
				600	4x62	6.60.02600	1.811	<b>1.349</b>	4x49	6.60.62600	2.517	<b>1.750</b>	4x84	6.61.12600	2.517	<b>1.750</b>
				700	4x87	6.60.02700	1.940	<b>1.449</b>	4x74	6.60.62700	2.647	<b>1.850</b>	4x109	6.61.12700	2.647	<b>1.850</b>
				800	4x112	6.60.02800	2.114	<b>1.549</b>	4x99	6.60.62800	2.832	<b>1.950</b>	4x134	6.61.12800	2.832	<b>1.950</b>
3 40kN	60	100	99	900	4x137	6.60.02900	2.302	<b>1.749</b>	4x124	6.60.62900	3.021	<b>2.050</b>	4x158,5	6.61.12900	3.021	<b>2.050</b>
				700	4x59	6.60.03700	2.244	<b>1.649</b>	4x44	6.60.63700	3.057	<b>2.150</b>	4x77	6.61.13700	3.057	<b>2.150</b>
				800	4x84	6.60.03800	2.428	<b>1.749</b>	4x69	6.60.63800	3.245	<b>2.250</b>	4x102	6.61.13800	3.245	<b>2.250</b>
				900	4x109	6.60.03900	2.619	<b>1.949</b>	4x94	6.60.63900	3.431	<b>2.450</b>	4x127	6.61.13900	3.431	<b>2.450</b>
				1000	4x134	6.60.03100	2.869	<b>2.149</b>	4x119	6.60.63100	3.682	<b>2.650</b>	4x152	6.61.13100	3.682	<b>2.650</b>

## OFFERTA PIASTRE PARALLELE MAGNETICHE E RIPORTATE

Art.616

Coppia di piastre parallele magnetiche piane per Art.600



RISPARMI IL  
**20%**

Solo se acquistate con la morsa



Art.610E

Piastra parallela riportata per Art.606

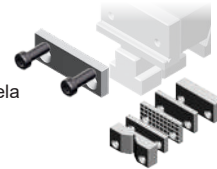

RISPARMI IL  
**20%**

Solo se acquistate con la morsa

# Morse MULTITASKING

Morse autocentranti o eccentriche - Ideali per centri di lavoro a 5 assi

**Art.640**

■ Possibile a richiesta 2 ganasce Art.645T anziché Art.645E

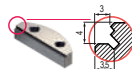

Dot. Standard : 1 arresto laterale, 1 chiave a pipa, 1 coppia di tasselli di orientamento Art.297, 1 perno di centraggio Art.640P

Tipo	1	2	3x166	3x266
Cod.	6.64.01000	6.64.02000	6.64.03166	6.64.03266
PREZZO LISTINO €	1.858	2.285	2.658	2.785
PREZZO OFFERTA €	<b>1.049</b>	<b>1.249</b>	<b>1.899</b>	<b>1.999</b>

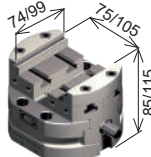

Rialzo Semplice per morsa Art.640 MONTAGGIO INCLUSO

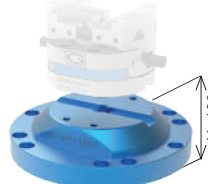

**Art.645B**  
Ganascia Dolce

Tipo	Cod.	PREZZO LISTINO €	PREZZO OFFERTA €
1	6.64.5B100	102	<b>77</b>
2	6.64.5B200	122	<b>93</b>
3	6.64.5B300	159	<b>121</b>



**Art.645C**  
Ganascia Liscia

Tipo	Cod.	PREZZO LISTINO €	PREZZO OFFERTA €
1	6.64.5C100	102	<b>77</b>
2	6.64.5C200	122	<b>93</b>
3	6.64.5C300	159	<b>121</b>



**Art.645D**  
Ganascia zigrinata

Tipo	Cod.	PREZZO LISTINO €	PREZZO OFFERTA €
1	6.64.5D100	102	<b>77</b>
2	6.64.5D200	122	<b>93</b>
3	6.64.5D300	159	<b>121</b>

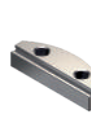

**Art.645E**  
Ganascia a gradino

Tipo	Cod.	PREZZO LISTINO €	PREZZO OFFERTA €
1	6.64.5E100	115	<b>87</b>
2	6.64.5E200	134	<b>102</b>
3	6.64.5E300	171	<b>130</b>



**Art.645F**  
Ganascia prismatica

Tipo	Cod.	PREZZO LISTINO €	PREZZO OFFERTA €
1	6.64.5F100	129	<b>98</b>
2	6.64.5F200	146	<b>111</b>
3	6.64.5F300	185	<b>141</b>



**Art.645T**  
Ganascia Grip (In dotazione a richiesta)

Tipo	Cod.	PREZZO LISTINO €	PREZZO OFFERTA €
1	6.64.5T100	129	<b>98</b>
2	6.64.5T200	146	<b>111</b>
3	6.64.5T300	185	<b>141</b>

**Art.641H**

Compatibili

Tipo	1	2	3x166	3x266
Cod.	7.64.1H100AL /100	7.64.1H200AL /100	7.64.1H3166AL /100	7.64.1H3266AL /100
PREZZO LISTINO €	640	753	769	1.167
PREZZO OFFERTA €	<b>400</b>	<b>450</b>	<b>600</b>	<b>900</b>

Rialzo con zero point per morsa Art.640 per cambio rapido. Dot Standard : 1 tirante Art.10S / 11S 1 tappo teflon con O-ring Art.9 - 1 perno di centraggio Art.640P, -1 spina di orientamento Art.79

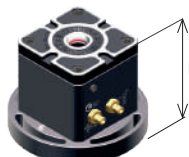

**Art.63**

Compatibili

**Art.64**

Tipo	1	2	Art.64
Altezza H	100	125	163
Cod.	9.63.10000	9.63.20000	9.64.20000
PREZZO LISTINO €	1.222	2.066	3.448
PREZZO OFFERTA €	<b>949</b>	<b>1.449</b>	-

# Cubi PORTAPEZZI

Fusioni in ghisa monoblocco con doppio trattamento di distensione - Per centri orizzontali

## STANDARD GIAPPONESE

### Art.53B

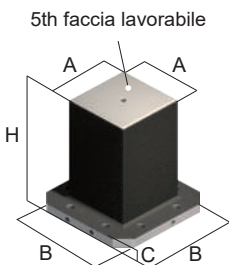

Cod.	A	B	C	D	H	Kg	PREZZO LISTINO €	PREZZO OFFERTA €
8.53.B00080	260	400	45	-	550	197	1.853	1.550
8.53.B00081	260	400	45	-	660	228	2.139	1.690
8.53.B00100	260	500	45	-	650	255	2.417	2.000
8.53.B00105	260	500	45	-	750	284	2.505	2.000
8.53.B00115	310	500	45	-	900	383	3.551	2.700
8.53.B00171	360	500	45	-	700	356	3.328	2.500
8.53.B00180	360	630	45	-	820	452	4.217	3.200
*8.53.B00211	510	630	45	-	860	61	5.858	3.850

\* Solo per pallet a cave a "T"

### Art.53B2 PLUS

Cod.	Kg	PREZZO LISTINO €	PREZZO OFFERTA €
8.53.B20080	182	2.361	1.950
8.53.B20081	204	2.680	2.050
8.53.B20100	238	3.027	2.400
8.53.B20105	254	3.138	2.500
8.53.B20115	354	4.311	3.300
8.53.B20171	326	4.041	3.050
8.53.B20180	427	5.277	4.200
8.53.B20211	593	7.113	4.350

### Art.55B

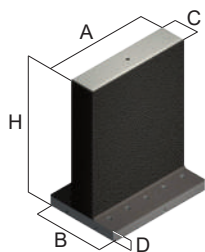

Cod.	A	B	C	D	H	Kg	PREZZO LISTINO €	PREZZO OFFERTA €
8.55.B00052	410	400	160	50	660	244	2.345	1.800
8.55.B00053	510	500	160	50	700	331	3.131	2.400
8.55.B00054	510	500	210	55	600	316	3.042	2.300
8.55.B00170	640	450	160	55	820	460	4.347	3.200
8.55.B00172	640	630	210	55	850	545	5.178	3.540
8.55.B00190	810	450	160	65	800	604	5.805	4.040

### Art.55B2 PLUS

Cod.	Kg	PREZZO LISTINO €	PREZZO OFFERTA €
8.55.B20052	206	2.846	2.150
8.55.B20053	303	3.801	2.900
8.55.B20054	301	3.693	2.800
8.55.B20170	433	5.278	4.000
8.55.B20172	520	6.288	4.500
8.55.B20190	782	7.048	4.900

### Art.57B

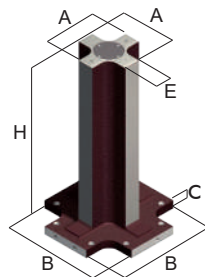

Cod.	A	B	C	D	H	Kg	PREZZO LISTINO €	PREZZO OFFERTA €
8.57.B00100	210	500	50	80	750	157	1.715	1.550
8.57.B00110	280	500	50	80	850	235	2.126	1.950
8.57.B00120	240	500	50	110	850	218	2.049	1.850
8.57.B00130	310	500	50	150	850	269	2.466	2.050
8.57.B00140	310	630	50	150	950	327	2.790	2.450

### Art.57B2 PLUS

Cod.	Kg	PREZZO LISTINO €	PREZZO OFFERTA €
8.57.B20100	155	2.075	1.850
8.57.B20110	241	2.608	2.300
8.57.B20120	216	2.556	2.250
8.57.B20130	232	2.974	2.550
8.57.B20140	325	3.293	2.650

**A** Fusione in ghisa G30 monoblocco con doppio trattamento di distensione. Pareti spessore 43-45 mm. Tolleranza +12 / -5 mm

**B** Fusione con base lavorata e raschiata per pallet a norme Giapponesi. Predisposizione della base di appoggio di n.4 fori Ø 20F7 e filetto M16 con interassi precisi, pronte per l'utilizzo dei ns. Zero Point, oppure per l'interfacciamento con altri pallet o piastre. Pronto da installare ed azzerare con assi macchina. Tolleranza +12 / -5 mm

**C** Cubo completamente finito con pareti spessore 38-40 mm circa. Tolleranza ± 0,02 mm

**B2 PLUS** Sovrametallo 1mm su ogni faccia. Pronto da installare e da azzerare con assi macchina.

**E** Cubo a reticolo con fori calibrati e filetti integrali. Tolleranza ± 0,02 mm

**F** Cubo a reticolo con bussole temprate 100 Cr6 e filetti riportati in acciaio inox. Tolleranza ± 0,02 mm

## CUBI E SPALLE VERSIONE LEGGERE

### Art.53B1

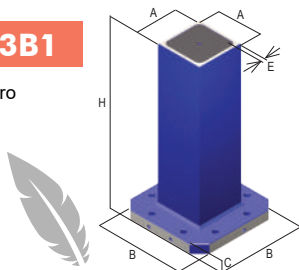
 Cubo Leggero  
Base Finita

**RISPARMI FINO AL**  
**20%**

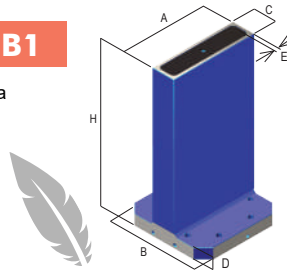
### Art.55B1

 Spalla Leggera  
Base Finita

**RISPARMI FINO AL**  
**20%**

A	B	C	E	H	Kg	Cod.	PREZZO LISTINO €	PREZZO OFFERTA €
210	400	45	25	750	167	8.53.B10055	1.853	1.500
260	400	45	25	850	229	8.53.B10085	2.235	1.800
260	500	45	25	750	234	8.53.B10105	2.439	1.950
360	500	50	30	900	400	8.53.B10182	3.453	2.700
360	630	45	30	950	468	8.53.B10185	4.135	3.250
460	630	45	35	950	634	8.53.B10205	5.161	4.250

E = Spessore pareti - Wall thickness

A	B	C	D	E	H	Kg	Cod.	PREZZO LISTINO €	PREZZO OFFERTA €
410	400	110	55	25	750	193	8.55.B10045	2.111	1.700
410	400	160	55	25	850	239	8.55.B10050	2.343	1.900
510	500	160	55	25	750	277	8.55.B10053	2.757	2.200
510	500	210	55	30	900	402	8.55.B10085	3.531	2.800
640	630	210	55	30	950	553	8.55.B10172	4.753	3.700

E = Spessore pareti - Wall thickness



# Unità e piastre **ZERO POINT**

Tempi di attrezzaggio ridotti del 90%, ripetibilità entro 0,005mm - Ideali per centri verticali, orizzontali e 5 assi

## IL CLASSICO PNEUMATICO MULTIPLO



### Art.664

CON FLANGIA

Tipo	Cod.	kN	Doppio Effetto kN	PREZZO LISTINO €	PREZZO OFFERTA €
1	9.66.41000	5,4		632	499
2	9.66.42000	10	NON DISPONIBILE	951	599
3	9.66.43000	16		1.194	999

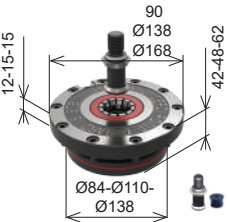

### Art.665

INCASSATO

Tipo	Cod.	kN	Doppio Effetto kN	PREZZO LISTINO €	PREZZO OFFERTA €
1	9.66.51000	5,4		509	399
2	9.66.52000	10	NON DISPONIBILE	826	499
3	9.66.53000	16		1.075	899

## L'ERMETICO PNEUMATICO SINGOLO

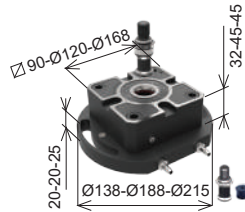

### Art.664S

CON FLANGIA

DOPIO EFFETTO ARIA+MOLLE

Tipo	Cod.	kN	Doppio Effetto kN	PREZZO LISTINO €	PREZZO OFFERTA €
1	9.66.4S100	5,4	12,7	732	599
2	9.66.4S200	10	27	1.037	699
3	9.66.4S300	16	40	1.194	999

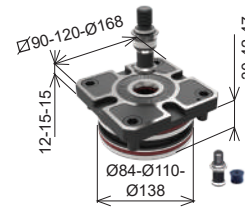

### Art.665S

INCASSATO

DOPIO EFFETTO ARIA+MOLLE

Tipo	Cod.	kN	Doppio Effetto kN	PREZZO LISTINO €	PREZZO OFFERTA €
1	9.66.5S100	5,4	12,7	610	499
2	9.66.5S200	10	27	914	599
3	9.66.5S300	16	40	1.075	899

Dot. Standard: 1 tirante Art.11A, 1 tappo teflon con O-Ring Art.9

Forza di serraggio 5 + 40 kN / Forza di arresto oltre a 60 kN / Sbloccaggio ad aria 6 + 10 bar / Compensazione assiale e radiale grazie alla pinza elastica integrale / Doppio centraggio per tirante per massima rigidità / Pulizia ad aria / Solo per ZERO POINT SINGOLI (versione S): 4 CHIAVETTE e FUNZIONE DOPPIOEFFETTO (Aria+molle)

## KIT SOVRATAVOLE IN ACCIAIO INTERFACCIAE CON ZERO POINT PNEUMATICI

KIT #1 E #2 POSIZIONAMENTO & FISSAGGIO INCLUSI

KIT #3 e #4 POSIZIONAMENTO E FISSAGGIO STANDARD INCLUSO E FISSAGGIO SPECIFICO **EXTRA\***

### KIT #1 PER CENTRI VERTICALI

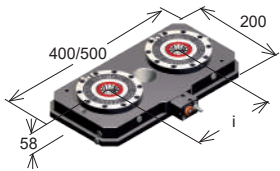

Art.81P PIASTRA BASE	PREZZO LISTINO €	PREZZO OFFERTA €
200x400 (i=200)	2.724	1.599
200x500 (i=250)	2.793	1.699

### KIT #2 PER CENTRI ORIZZONTALI

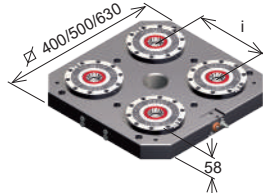

Art.80P PIASTRA BASE	PREZZO LISTINO €	PREZZO OFFERTA €
400x400 (i=200)	4.880	3.299
500x500 (i=250)	5.107	3.499
630x630 (i=300)	5.595	3.999

### KIT #3 PER CENTRI VERTICALI

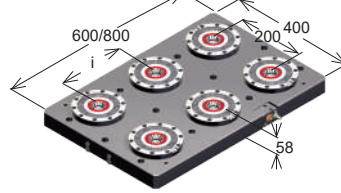

Art.81P PIASTRA BASE	PREZZO LISTINO €	PREZZO OFFERTA €
400x600 (i=200)	7.035	4.699
400x800 (i=300)	7.332	4.899

### KIT #4 PER CENTRI A 5 ASSI

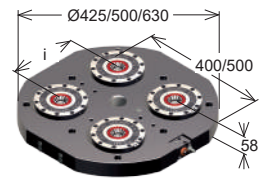

Art.82P PIASTRA BASE TONDA	PREZZO LISTINO €	PREZZO OFFERTA €
Ø425 (i=200)	5.107	3.399
Ø500 (i=250)	5.085	3.499
Ø630 (i=300)	5.674	3.999

## PIASTRE D'INTERFACCIA PER PIASTRE ZERO POINT

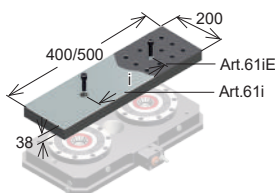

Art.61iC LISCE	PREZZO LISTINO €	PREZZO OFFERTA €
200x400 (i=200)	936	599
200x500 (i=250)	1.006	649

Art.61iE A RETICOLO INTEGRALE	PREZZO LISTINO €	PREZZO OFFERTA €
200x400 (i=200)	1.135	649
200x500 (i=250)	1.250	749

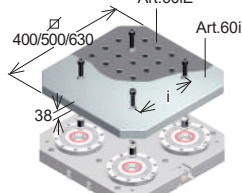

Art.60iC LISCE	PREZZO LISTINO €	PREZZO OFFERTA €
400x400 (i=200)	1.146	863
500x500 (i=250)	1.380	1.039
630x630 (i=300)	1.730	1.303

Art.60iE A RETICOLO INTEGRALE	PREZZO LISTINO €	PREZZO OFFERTA €
400x400 (i=200)	1.505	1.040
500x500 (i=250)	1.968	1.360
630x630 (i=300)	3.090	2.136

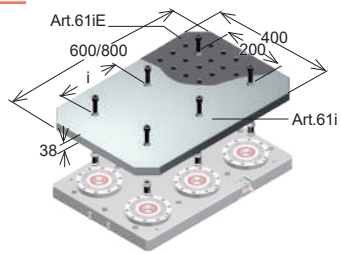

Art.61iC LISCE	PREZZO LISTINO €	PREZZO OFFERTA €
400x600 (i=200)	1.753	1.320
400x800 (i=300)	2.337	1.760

Art.61iE A RETICOLO INTEGRALE	PREZZO LISTINO €	PREZZO OFFERTA €
400x600 (i=200)	2.083	1.440
400x800 (i=300)	2.962	2.048

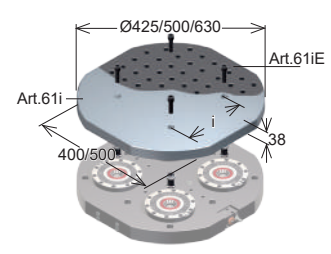

Art.62iC LISCE	PREZZO LISTINO €	PREZZO OFFERTA €
Ø425 (i=200)	1.228	924
Ø500 (i=250)	1.402	1.056
Ø630 (i=300)	1.636	1.232

Art.62iE A RETICOLO INTEGRALE	PREZZO LISTINO €	PREZZO OFFERTA €
Ø425 (i=200)	1.505	1.040
Ø500 (i=250)	1.921	1.328
Ø630 (i=300)	2.569	1.776

# Morse GRIP MATIC

Morsa automatica pneumatica o idraulica a doppio effetto - Ideale per centri a 5 assi

## Art.670



Dot. Standard: - 4x Viti calibrate (Art.83) - Perno di centraggio (Art.670P)  
- 2 Niplon o 2 raccordi Art.PN04 - Valvola di non ritorno (Art.PN16)



Modulo base morsa autocentrante idraulica o pneumatica

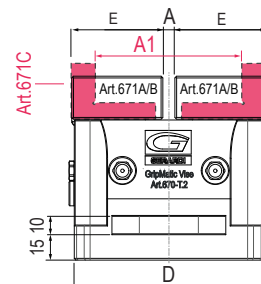
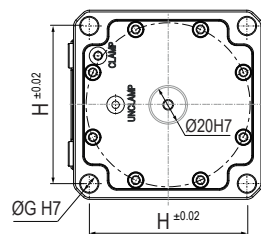
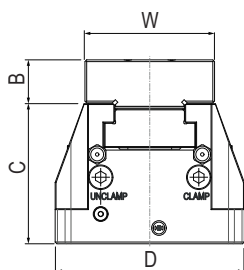

Tipo	Larghezza ganascia W	Apertura minima A	Apertura massima A1	Altezza morsa C+B	Altezza base C	Larghezza morsa D	Lunghezza ganascie E	Interasse fori di centraggio e fissaggio H	Pressione di esercizio	PNEUMATICO ART.670		IDRAULICO ART.670		PREZZO LISTINO €	PREZZO OFFERTA €	
										Forza	Cod.	Forza	Cod.			
2	74	6,4	88,9	105	80	106	52	90	Max 10BAR	7 kN	7.67.0PN20	30BAR	19 kN	7.67.0ID20	1.790	1.400
3	99	8,5	130,2	135	105	166	78	140		14,4 kN	7.67.0PN30	30BAR	37,5 kN	7.67.0ID30	2.387	1.850
4	124	12	162	165	130	206	96	170		16,9 kN	7.67.0PN40	25 BAR	47 kN	7.67.0ID40	3.162	2.400

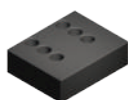

Art.671A  
Ganascia lavorabile



Art.671B  
Ganascia lavorabile ridotta

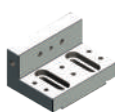

Art.671C  
Ganascia lavorabile ridotta



Art.243  
Piastra ganascia piana rigata temprata



Art.245  
Piastra ganascia piana liscia temprata



Art.247G  
Piastra piana con inserti GRIP

## PIASTRE D'INTERFACCIA PER MORSE GRIPMATIC - IDEALI PER CENTRI A 5 ASSI

### Art.670CP

### SEMI-AUTOMATICA

Piastra di interfaccia per morsa Grip Matic Art.670 PN semiautomatica con innesto aria tramite attacco rapido e apertura e chiusura gestiti manualmente tramite selettore

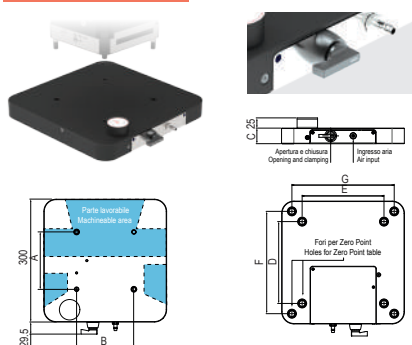

Tipo	Interasse fori A	Interasse fori B	Altezza piastra C	Interasse fori (Zero Point) D	Interasse fori (Zero Point) E	Interasse fori (Zero Point) F	Interasse fori (Zero Point) G	Pressione di esercizio	Forza	Cod.	PREZZO LISTINO €
2	90	90	38	200	200	250	250	Max 10BAR	7 kN	7.67.0CP20	2.271
3	140	140	38	200	200	250	250		14,4 kN	7.67.0CP30	2.271
4	170	170	38	200	200	250	250		16,9 kN	7.67.0CP40	2.271

### Art.670AP

### AUTOMATICA

Piastra di interfaccia per morsa Grip Matic Art.670PN automatica con innesto aria tramite la piastra della macchina e gestibile direttamente dal CNC. Piastra completamente personalizzabile in base alle funzionalità della macchina utensile (comando di presenza pezzo e pulizia)

\* Prezzo base minimo, PERSONALIZZAZIONE INCLUSA

### PIASTRA PERSONALIZZABILE AL 100%

Tipo	Pressione di esercizio	Forza	ART.670 Pneumatico Cod.	PREZZO LISTINO €*
2	Max 10BAR	7 kN	7.67.0AP20	2.497
3		14,4 kN	7.67.0AP30	2.497
4		16,9 kN	7.67.0AP40	2.497

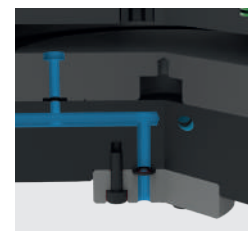
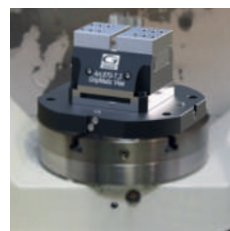

# DUODUX

L'autocentrante doppia guida italiano

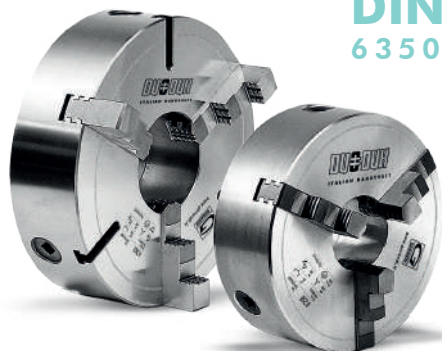
**DIN**  
**6350**

Dot. standard: 1 set da 3 griffe con presa interna, 1 set da 3 griffe con presa esterna, 1 chiave mandrino per apertura griffe

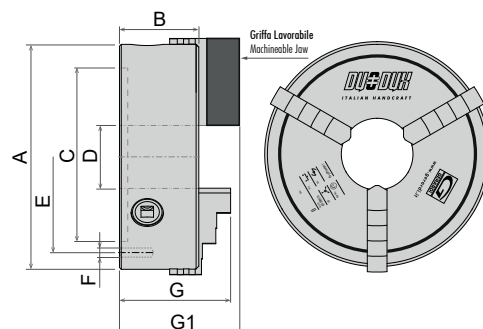
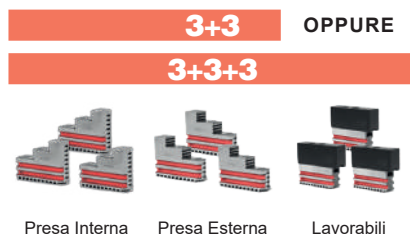

	A	B	C h6	D	E	F	G	G1	daN	Rpm
GUIDA SINGOLA	Ø160	70,5	130	42	144,5	N°3 M8	89,5	106	3.100	Max 3.600
DOPPIA GUIDA	Ø200	81	160	53	176	N°3 M10	113	132,5	3.700	Max 3.000
DOPPIA GUIDA	Ø250	88,5	200	80	224	N°6 M12	124	149,5	4.600	Max 2.500
DOPPIA GUIDA	Ø310	100,5	260	108	286	N°3 M12	143,5	162,5	5.500	Max 2.000
DOPPIA GUIDA	Ø365	105,5	310	126,5	336,5	N°6 M14	155	168	5.900	Max 1.800
DOPPIA GUIDA	Ø430	114	382	170	405	N°6 M14	170	176,5	6.900	Max 1.400

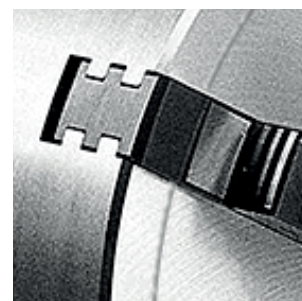

	3+3				3+3+3				
	A	Kg	Cod.	PREZZO LISTINO €	PREZZO OFFERTA €	Kg	Cod.	PREZZO LISTINO €	PREZZO OFFERTA €
GUIDA SINGOLA	Ø160	8	GMD-160-3G20	1.067	854	10	GMD-160-3G30	1.333	1.066
DOPPIA GUIDA	Ø200	15	GDD-200-3G20	1.156	925	18	GDD-200-3G30	1.444	1.155
DOPPIA GUIDA	Ø250	23	GDD-250-3G20	1.358	1.086	27	GDD-250-3G30	1.650	1.320
DOPPIA GUIDA	Ø310	38	GDD-310-3G20	1.984	1.587	44	GDD-310-3G30	2.319	1.855
DOPPIA GUIDA	Ø365	61	GDD-365-3G20	3.092	2.474	71	GDD-365-3G30	3.760	3.008
DOPPIA GUIDA	Ø430	92	GDD-430-3G20	4.345	3.476	103	GDD-430-3G30	5.180	4.144



## PRECISIONE, RIGIDITÀ & STABILITÀ ANCHE IN LAVORAZIONI GRAVOSE

DUO-DUX, il mandrino autocentrante manuale a doppia guida 100% Made in Italy. Composto da griffe integrali a guida doppia in grado di sopportare maggiori carichi di lavoro e garantire una maggior stabilità. La corona è rettificata con uno speciale metodo da noi sviluppato atto a garantire elevata precisione e ripetibilità. Ogni autocentrante DUO-DUX viene equilibrato secondo la norma ISO3089/74, testato singolarmente e fornito di apposito certificato di collaudo e garanzia. Gli autocentranti di diametro 365 e 430mm, indicati per lavorazioni pesanti, conservano al contempo le stesse doti tecniche di precisione dei mandrini di minor diametro.

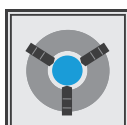
**PIÙ ALTA RIGIDITÀ**

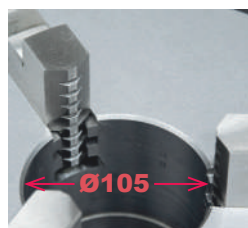
**GARANTITO 5 ANNI**

**CORPO IN GHISA**

**Versione speciale Ø270-105**

Oltre ai diametri della gamma standard è disponibile una versione speciale con Ø270 e passaggio barra maggiorato Ø105.

Cod. GDD-270-3G20-105

**Griffe Integrali**

Le griffe integrali per il serraggio sono realizzate in acciaio al nichel-cromo cementato, temprato e rettificato a garantire elevata precisione e ripetibilità.

**Doppia guida**

Il sistema a doppia guida degli autocentranti DuoDux è in grado di sopportare maggiori carichi di lavoro e garantire maggior stabilità.

**5 Anni di Garanzia**

Sicuri dell'affidabilità e dell'elevata qualità dei componenti impiegati per la realizzazione degli autocentranti DuoDux riconosciamo 5 anni di garanzia sull'intera gamma.

# Portautensili **STATICI**

Risparmia con i kit di statici - A scelta tra la gamma a catalogo



SCANSIONA IL QR CODE E SCEGLI TRA L'INTERA GAMMA DI COSTRUTTORI DI STATICI PRESENTI A CATALOGO

DIN 69880

DMG MORI

Mazak

LOKUMA

BMT

Bolt Mounted Turret



Nakamura-Tome



TSUGAMI CORPORATION

Richiedi la password al tuo agente di zona

ESEMPIO KIT 1

3 PCS

RISPARMI IL  
**10%**

ESEMPIO KIT 2

4 PCS

RISPARMI IL  
**15%**

ACQUISTANDO **3 PORTAUTENSILI STATICI**

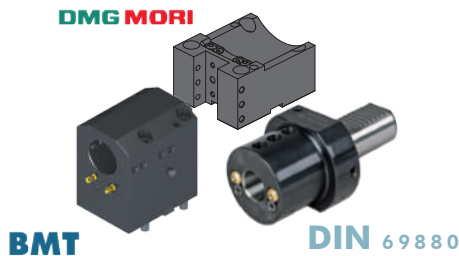

ACQUISTANDO **4 PORTAUTENSILI STATICI**

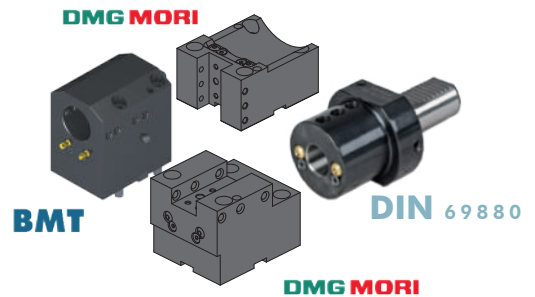

## Cambi rapidi **MODULARI**

Nuovi cambi rapidi universali 2.0 - Compatibili con tutte le uscite ER

RISPARMI FINO AL  
**50%**

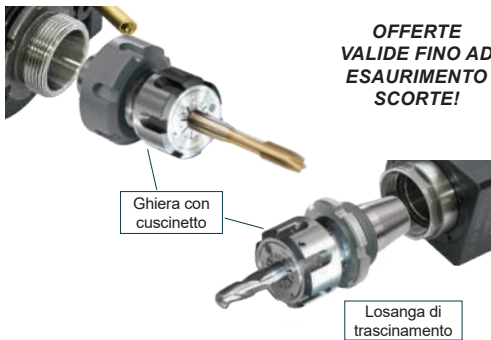

OFFERTE  
VALIDE FINO AD  
ESAURIMENTO  
SCORTE!

**BREVETTO DEPOSITATO**

LOSANGA DI TRASCINAMENTO



PREZZO DI LISTINO 425€ CAD.

- Tempi di installazione ridotti e possibilità di presetting a bordo macchina
- Nuovi cambi rapidi modulari 2.0 a FORTE SER-RAGGIO
- Portautensili modulari compatibili con tutte le uscite ER
- Prestazioni garantite e maggior rigidità sui motorizzati Gerardi grazie alla losanga di trascinamento (rimovibile) e alla ghiera con cuscinetto a sfera
- Adattabili a motorizzati con uscita refrigerante sia interna che esterna
- Si consiglia di non superare i 10.000Rpm utilizzando i cambi rapidi

3 PCS

ACQUISTANDO  
**3 CAMBI RAPIDI**  
(GHIERA INTERNA O ESTERNA)

4 PCS

ACQUISTANDO  
**4 CAMBI RAPIDI**  
(GHIERA INTERNA O ESTERNA)

**WOOW**

ACQUISTA UN MOTORIZZATO CON USCITA  
ER25, ER32 o ER40  
**1 CAMBIO RAPIDO A SCELTA**  
(GHIERA INTERNA O ESTERNA)



KIT1

RISPARMI IL  
**20%**



KIT2

RISPARMI IL  
**25%**



KIT3

RISPARMI IL  
**50%**

Sul Cambio Rapido



# Portautensili **MOTORIZZATI**

Motorizzati per torni cnc - L'eccellenza tecnologica

**MODELLI  
HIGH PERFORMANCE  
DISPONIBILI  
(+ COPPIA, + RPM)**

## BMT

COMPATIBILI CON TORNI

Bolt Mounted Turret

**DOOSAN / HARDINGE / SAMSUNG / HWACHEON / HYUNDAI WIA / VICTOR / HAAS**

**BMT 65 COMPATIBILI ANCHE CON TORNI HAAS!**

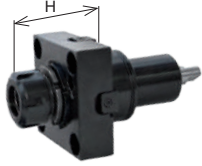

**80  
BAR**

### Assiali

BMT	Cod.	ER	H Max	Nm	Rpm	PREZZO LISTINO €	PREZZO OFFERTA €
45	99.DS.A03	25	57,2	35	8000	1.033	<b>839</b>
	99.DS.A04	25	57,2	35	8000	1.179	<b>929</b>
55	99.DS.A01	25	57,2	40	8000	1.363	<b>899</b>
	99.DS.A02	25	57,2	40	8000	1.243	<b>979</b>
65 HAAS READY!	99.DS.A41	32	72,5	70	6000	1.274	<b>1.049</b>
	99.DS.A42	32	72,5	70	6000	1.465	<b>1.179</b>
75	99.DS.A34	40	90,2	100	6000	1.497	<b>1.249</b>
	99.DS.A35	40	90,2	100	6000	1.720	<b>1.399</b>



**80  
BAR**

### Radiali

BMT	Cod.	ER	H	Nm	Rpm	PREZZO LISTINO €	PREZZO OFFERTA €
45	99.DS.A07C	25	65	35	8000	1.822	<b>1.499</b>
	99.DS.A08C	25	65	35	8000	2.190	<b>1.799</b>
55	99.DS.A11C	25	70	40	8000	2.038	<b>1.599</b>
	99.DS.A12C	25	70	40	8000	2.408	<b>1.899</b>
65 HAAS READY!	99.DS.A51C	32	72	70	6000	2.140	<b>1.699</b>
	99.DS.A52C	32	72	70	6000	2.534	<b>1.999</b>
75	99.DS.A38C	40	60	100	6000	3.311	<b>2.649</b>
	99.DS.A39C	40	60	100	6000	3.973	<b>3.099</b>

Entrambe direzioni di rotazione disponibili



**80  
BAR**

### Orientabili

BMT	Cod.	ER	H	Nm	Rpm	PREZZO LISTINO €	PREZZO OFFERTA €
45	99.DS.A16	20	65	15	8000	4.698	<b>3.899</b>
	99.DS.A17	20	65	15	8000	6.111	<b>4.699</b>
55	99.DS.A23	20	65	15	8000	4.698	<b>3.899</b>
	99.DS.A66	20	65	15	8000	6.111	<b>4.699</b>
65 HAAS READY!	99.DS.A64	25	75	25	6000	5.221	<b>4.299</b>
	99.DS.A65	25	75	25	6000	6.748	<b>5.199</b>
75	99.DS.A47	25	75	25	6000	5.221	<b>4.299</b>
	99.DS.A48	25	75	25	6000	6.748	<b>5.199</b>

## ATTACCO BMT CON TENONE STANDARD

Disponibile anche versione High Performance con Tenone Maggiorato a Richiesta

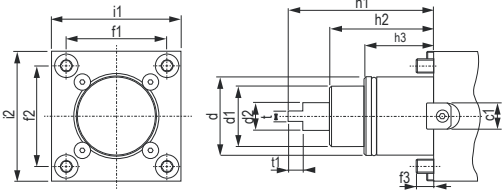

BMT	c1	d	d1	d2	f1	f2	f3	h1	h2	h3	i1	i2	t	t2	h4	N	ØM
45	15	Ø45	35	14	58	58	10	84	60	40	75	75	6	8,5	-	-	-
55	15	Ø55	40	16	64	64	14	104	75	30	85	85	8	8,5	9,5	8	29
65	18	Ø65	45	18	70	73	15	112	83	32	94	94	10	14	15	10	29
75	25	Ø75	55	23	90	90	15	110	80	43	112	112	14	15	-	-	-
85	25	Ø85	65	33,5	100	100	18	140	100	43	125	125	16	20	-	-	-

## IN OFFERTA LE NUOVE GAMME DI MOTORIZZATI

### Mazak QTN3

QUICK TURN NEXUS QTN  
300 / 350 / 400 / 450 -  
SQT 28 / 30 - 300

**80  
BAR**

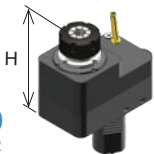

#### Disassati

Cod.	ER	H	Nm	Rpm	PREZZO LISTINO €	PREZZO OFFERTA €
99.MZ.A71	40	145	100	4000	3.320	<b>3.100</b>
99.MZ.A72	40	145	100	4000	3.631	<b>3.300</b>

### Mazak QTN2

QUICK TURN NEXUS  
QTN 200 / 250  
SUPER QUADREX TURN  
SQT 15/18 - 200 / 250

**80  
BAR**

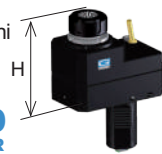

Cod.	ER	H	Nm	Rpm	PREZZO LISTINO €	PREZZO OFFERTA €
99.MZ.A58	32	120	80	6000	2.491	<b>1.549</b>
99.MZ.A59	32	120	80	6000	3.010	<b>2.100</b>

### Mazak SMART QTS1 - BMT68

QUICK TURN SMART  
QTS 100M / 200M  
QT COMPACT 100M -  
200M - 300M

**80  
BAR**



Cod.	ER	H Max	Nm	Rpm	PREZZO LISTINO €	PREZZO OFFERTA €
99.MZ.A03	32	70	60	6000	1.972	<b>1.749</b>
99.MZ.A06	32	70	60	6000	2.387	<b>2.149</b>

#### Radiali

**80  
BAR**



Cod.	ER	H	Nm	Rpm	PREZZO LISTINO €	PREZZO OFFERTA €
99.MZ.A75	40	160	100	4000	3.424	<b>3.200</b>
99.MZ.A81	40	160	100	4000	3.943	<b>3.600</b>

**80  
BAR**



Cod.	ER	H	Nm	Rpm	PREZZO LISTINO €	PREZZO OFFERTA €
99.MZ.A65	32	120	80	6000	2.698	<b>1.649</b>
99.MZ.A66	32	120	80	6000	2.906	<b>1.949</b>

Senso di rotazione contrario al mandrino

**80  
BAR**



Cod.	ER	H	Nm	Rpm	PREZZO LISTINO €	PREZZO OFFERTA €
99.MZ.A09	32	80	60	6000	2.698	<b>2.299</b>
99.MZ.A10	32	80	60	6000	2.906	<b>2.599</b>

Senso di rotazione contrario al mandrino



# Portautensili **MOTORIZZATI**

Motorizzati per torni cnc - L'eccellenza tecnologica

**MODELLI  
HIGH PERFORMANCE  
DISPONIBILI  
(+ COPPIA, + RPM)**

## DIN 5480

### VDI - DIN69880

\* In caso di ordine specificare sempre se sinistro o destro



d1	Cod.	ER	H	Nm	Rpm	PREZZO LISTINO €	PREZZO OFFERTA €
30	99.ST.8003	25	66	32	6000	917	779
	99.ST.8011	25	66	32	6000	1.185	979
40	99.ST.8005	32	95	63	6000	1.147	999
	99.ST.8013	32	95	63	6000	1.499	1.229
Senso di rotazione uguale al mandrino							
30	99.ST.8030	25	55	32	6000	1.926	1.599
	99.ST.8038	25	55	32	6000	2.216	1.829
40	99.ST.8033	32	100	63	6000	2.436	1.999
	99.ST.8041	32	100	63	6000	2.798	2.299
Senso di rotazione contrario al mandrino							

## DIN 5482

### VDI - DIN69880

\* In caso di ordine specificare sempre se sinistro o destro



d1	Cod.	ER	H	Nm	Rpm	PREZZO LISTINO €	PREZZO OFFERTA €
30	99.ST.8201	25	94	32	6000	865	779
	99.ST.8207	25	94	32	6000	1.161	979
40	99.ST.8203	32	115	63	5000	1.041	899
	99.ST.8208	32	115	63	5000	1.347	1.129
Senso di rotazione uguale al mandrino							
30	99.ST.8217	25	55	32	6000	1.735	1.449
	99.ST.8223	25	55	32	6000	2.025	1.699
40	99.ST.8220	32	100	63	5000	2.078	1.699
	99.ST.8226	32	100	63	5000	2.430	1.999
Senso di rotazione contrario al mandrino							



### VDI - DIN69880

\* In caso di ordine specificare sempre se sinistro o destro



d1	Cod.	ER	H	Nm	Rpm	PREZZO LISTINO €	PREZZO OFFERTA €
30	99.BF.0003	25	94	32	6000	895	779
	99.BF.0010	25	94	32	6000	1.193	979
40	99.BF.0005	32	117	63	5000	1.079	929
	99.BF.0011	32	115	63	5000	1.391	1.179
Senso di rotazione uguale al mandrino							
30	99.BF.0021	25	55	32	6000	1.781	1.499
	99.BF.0027	25	55	32	6000	2.086	1.749
40	99.BF.0024	32	100	63	5000	2.140	1.749
	99.BF.0030	32	100	63	5000	2.506	2.049
Senso di rotazione contrario al mandrino							

## DIN 1809

### VDI - DIN69880

\* In caso di ordine specificare sempre se sinistro o destro

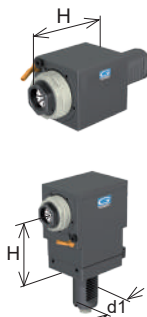

d1	Cod.	ER	H	Nm	Rpm	PREZZO LISTINO €	PREZZO OFFERTA €
30	99.DP.0903	25	94	32	6000	865	779
	99.DP.0910	25	94	32	6000	1.161	979
40	99.DP.0905	32	115	63	5000	1.041	879
	99.DP.0911	32	115	63	5000	1.347	1.129
Senso di rotazione uguale al mandrino							
30	99.DP.0919	25	55	32	6000	1.735	1.449
	99.DP.0925	25	55	32	6000	2.025	1.699
40	99.DP.0922	32	100	63	5000	2.078	1.699
	99.DP.0928	32	100	63	5000	2.430	1.999
Senso di rotazione contrario al mandrino							



### BMT 55

CORPO MONOBLOCCO NICHELATO



d1	Cod.	Biglia Code	ER	H	Nm	Rpm	PREZZO LISTINO €	PREZZO OFFERTA €
55	99.BG.A01	10.57.88.00	25	70	47	6000	887	699
	99.BG.A02	T.134-00061	32	70	47	6000	887	699
	99.BG.A03	T.134-00071	32	70	47	6000	1.227	949

Senso di rotazione uguale al mandrino

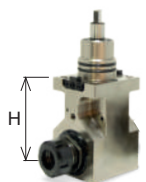

d1	Cod.	Biglia Code	ER	H	Nm	Rpm	PREZZO LISTINO €	PREZZO OFFERTA €
55	99.BG.A05	10.57.87.00	25	70	47	6000	1.661	1.249
	99.BG.A06	T.134-00062	32	70	47	6000	1.661	1.249
	99.BG.A07	T.134-00072	32	70	47	6000	2.179	1.649
	99.BG.A08	T.134-00076	25	100	47	6000	1.868	1.399
	99.BG.A09	T.134-00077	32	100	47	6000	1.868	1.399
	99.BG.A10	T.134-00088	32	100	47	6000	2.179	1.649

Senso di rotazione uguale al mandrino

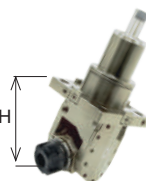

d1	Cod.	Biglia Code	ER	H	Nm	Rpm	PREZZO LISTINO €	PREZZO OFFERTA €
55	99.BG.A15	T.134-00025	16	60	16	6000	3.830	2.849
	99.BG.A16	T.134-00057	20	60	16	6000	3.830	2.849

Senso di rotazione uguale al mandrino



### NLX 1500 - 2000 - 2500 - 3000

12 Posizioni

### NZX 12 Posizioni

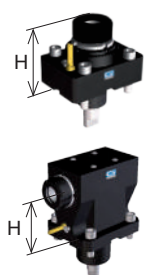

Cod.	ER	H <sub>Max</sub>	Nm	Rpm	PREZZO LISTINO €	PREZZO OFFERTA €
99.MS.A59	32	89,9	60	10.000	1.249	999
99.MS.A60	32	89,9	60	10.000	1.847	1.429
99.MS.A62	40	92	60	10.000	1.249	999
99.MS.A63	40	92	60	10.000	1.847	1.429
99.MS.A72	32	90	60	10.000	2.674	2.099
99.MS.A73	32	90	60	10.000	2.993	2.349
99.MS.A76	40	90	60	10.000	2.674	2.099
99.MS.A77	40	90	60	10.000	2.993	2.349

Entrambe direzioni di rotazione disponibili\*

### NZ 1500 - 2000 - 3100 - 3150 - 3200

16 Posizioni



Cod.	ER	H <sub>Max</sub>	Nm	Rpm	PREZZO LISTINO €	PREZZO OFFERTA €
99.MS.A101	25	84,3	50	12.000	1.249	1.049
99.MS.A102	25	84,3	50	12.000	1.847	1.479
99.MS.A103	32	89,2	50	12.000	1.249	1.049
99.MS.A104	32	89,2	50	12.000	1.847	1.479
Senso di rotazione uguale al mandrino						
99.MS.A106	25	85	50	12.000	2.674	2.099
99.MS.A107	25	85	50	12.000	2.993	2.349
99.MS.A108	32	85	50	12.000	2.674	2.099
99.MS.A109	32	85	50	12.000	2.993	2.349

Senso di rotazione contrario al mandrino



# Portautensili **MOTORIZZATI**

Motorizzati per torni cnc - L'eccellenza tecnologica

**MODELLI  
HIGH PERFORMANCE  
DISPONIBILI  
(+ COPPIA, + RPM)**



**VDI 40**



Cod.	ER	H	h1	Nm	Rpm	PREZZO LISTINO €	PREZZO OFFERTA €
99.HA.590082	32	75	117,5	63	6000	945	749
99.HA.590082B	32	75	117,5	63	6000	1.179	899
99.HA.590083	32	75	104,8	63	6000	945	749
99.HA.590083B	32	75	104,8	63	6000	1.179	899
99.HA.596352	32	75	130,25	63	6000	945	749
99.HA.596352B	32	75	130,25	63	6000	1.179	899

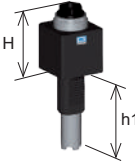

Senso di rotazione uguale al mandrino



\* Presa di moto intercambiabile per le varie tipologie di torrette Haas

Cod.	ER	H	h1	Nm	Rpm	PREZZO LISTINO €	PREZZO OFFERTA €
99.HA.590084	32	75	117,5	63	6000	1.773	1.349
99.HA.590084B	32	75	117,5	63	6000	2.240	1.699
99.HA.590085	32	75	104,8	63	6000	1.773	1.349
99.HA.590085B	32	75	104,8	63	6000	2.240	1.699
99.HA.596353	32	75	130,25	63	6000	1.773	1.349
99.HA.596353B	32	75	130,25	63	6000	2.240	1.699



Senso di rotazione uguale al mandrino



**Ø45: WT100 -TW1**  
**Ø54: WT100 -TW1**



d1	Cod.	ER	H Max	Nm	Rpm	PREZZO LISTINO €	PREZZO OFFERTA €
45	99.MY.A02	25	57,6	35	6000	853	749
	99.MY.A03	25	57,6	35	6000	1.022	899
	99.MY.A09	32	79,4	60	6000	993	849
54	99.MY.A10	32	79,4	60	6000	1.140	949
	99.MY.A05	25	65	35	6000	1.506	1.249
45	99.MY.A06	25	65	35	6000	2.456	1.649
	99.MY.A11	32	75	60	6000	2.284	1.899
	99.MY.A12	32	75	60	6000	2.207	1.849

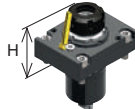

Senso di rotazione contrario al mandrino



**BMT44 WT100 -TW1**  
**BMT55 SUPER NTJ-NTJX/NTM 3/TMC 18/**  
**TW10/SC150-250/WT150-250/WTW 150/WTS 150/WT100**



d1	Cod.	ER	H Max	Nm	Rpm	PREZZO LISTINO €	PREZZO OFFERTA €
45	99.NK.A40	25	57,2	40	6000	946	799
	99.NK.A43	25	57,2	40	6000	1.081	899
55	99.NK.A03	32	72,2	63	6000	993	849
	99.NK.A04	32	72,2	63	6000	1.530	1.299
45	99.NK.A50	25	60	40	6000	1.676	1.399
	99.NK.A53	25	60	40	6000	2.008	1.699
55	99.NK.A13	32	55	63	6000	1.868	1.549
	99.NK.A14	32	55	63	6000	2.519	2.099



**BMT60: SPACE TURN LB 200EX/LB 2500EX/LB3000EX/GENOS SERIES L300-MW/**  
**MULTUS U3000/U40007/LU3000EX M/MY**



d1	Cod.	ER	H Max	Nm	Rpm	PREZZO LISTINO €	PREZZO OFFERTA €
60	99.OK.A80	32	79	60	6000	1.687	1.299
	99.OK.A81	32	79	60	6000	2.141	1.599
60	99.OK.A82	32	70	60	6000	3.048	2.299
	99.OK.A83	32	70	60	6000	3.631	2.749

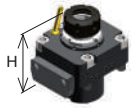

Senso di rotazione uguale al mandrino

Senso di rotazione contrario al mandrino



**VDI40 OKUMA CAPTAIN L370 M - ES L10 M - GENOS L300, L3000-E M/MY (VDI40)**  
**LB 300 MW - LB/LU 300 MY - LB/LU 300, 3000 M (VDI40)**



**Assiali**

Cod.	ER	H	Nm	Rpm	PREZZO LISTINO €	PREZZO OFFERTA €
99.OK.A18	32	98,6	70	6000	1.947	1.499
99.OK.A23	32	98,6	70	6000	2.465	1.899



**Radiali**

Cod.	ER	H	Nm	Rpm	PREZZO LISTINO €	PREZZO OFFERTA €
99.OK.A19	32	70	60	6000	3.373	2.549
99.OK.A25	32	70	60	6000	4.151	3.149

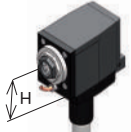

**BMT60 EX 380 / 310 / 508 / 510 / 708 / 710 / 910 - EX 2000 M/Y - TC 350 MC - TT 350 MC - NEX 108/110/908/910 - LA 200/250 M/Y - LA 250 YS (15 stations) - FX 800 - MX 800 - VTL 450 M - LX 2500 M/Y**



**Assiali**

Cod.	ER	H	Nm	Rpm	PREZZO LISTINO €	PREZZO OFFERTA €
99.TK.A12	32	93	50	6000	1.499	1.149
99.TK.A13	32	93	50	6000	2.213	1.699



**Radiali**

Cod.	ER	H	Nm	Rpm	PREZZO LISTINO €	PREZZO OFFERTA €
99.TK.A02	32	90	50	6000	3.139	2.399
99.TK.A05	32	90	50	6000	3.333	2.549



**BMT65: M06D/M06SD/M06SY/M08SD/M08SY**



**Assiali**

Cod.	ER	H Max	Nm	Rpm	PREZZO LISTINO €	PREZZO OFFERTA €
99.TS.A01	25	60	40	8000	1.558	1.099
99.TS.A03	32	60	40	8000	2.141	1.499
99.TS.A02	25	60	40	8000	2.141	1.499
99.TS.A04	32	60	40	8000	2.141	1.499



**Radiali**

Cod.	ER	H	Nm	Rpm	PREZZO LISTINO €	PREZZO OFFERTA €
99.TS.A08	25	65	40	8000	2.529	1.749
99.TS.A10	32	65	40	8000	3.112	2.199
99.TS.A09	25	65	40	8000	3.112	2.199
99.TS.A11	32	65	40	8000	3.112	2.199



# TESTE ANGOLARI e MOLTIPLICATORI di Giri

Novità!! Da oggi anche le teste angolari classic line a prezzo speciale

## DOTAZIONE STANDARD

Valigetta / Stop block / Ghiera ER /  
Chiavi di servizio /  
Tubetto di grasso / Libro istruzioni

Vai alla pagina  
di catalogo per  
approfondire



Ratio  
1:1



Rpm  
8.000



Kg 5,4



ER25  
Ø1/16

### CLASSIC LINE ATC

# G90-16

Prezzo Listino ~~€ 3.598~~  
Prezzo Speciale: **€ 3.000**

## DOTAZIONE STANDARD

Valigetta / Stop block / Ghiera ER /  
Chiavi di servizio /  
Tubetto di grasso / Libro istruzioni

Vai alla pagina  
di catalogo per  
approfondire



Ratio  
1:1



Rpm  
4.000



Kg 11



ER32  
Ø2/20

### CLASSIC LINE ATC

# G90-20

Prezzo Listino ~~€ 3.804~~  
Prezzo Speciale: **€ 3.200**



## AMPIA GAMMA DI MODELLI

quasi 200 modelli di teste  
classic line disponibili

## MASSIMA RIGIDITÀ

grazie ad albero e cono  
integrali realizzati in un pezzo  
unico

## CORPO ORIENTABILE A 360°

in acciaio temprato, massima  
rigidità e resistenza alla  
corrosione

## CUSCINETTI ABEC 9

a contatto obliquo, precaricati  
e lubrificati con grasso a vita

## INGRANAGGI GLEASON

garantiscono minor riscalda-  
mento e rumorosità ed elevato  
numero di giri

## DOTAZIONE STANDARD

Valigetta / Stop block / Ghiera ER /  
Chiavi di servizio /  
Tubetto di grasso / Libro istruzioni

Vai alla pagina  
di catalogo per  
approfondire



Ratio  
1:1



Rpm  
5.000



ISO / BT 40  
Kg 7  
ISO / BT 50  
Kg 12



ER32  
Ø2/20

### EVOLUTION LINE ATC

# F90-20S

Prezzo Listino ~~€ 3.749~~  
Prezzo Speciale: **€ 3.000**

## DOTAZIONE STANDARD

Valigetta / Stop block / Ghiera ER /  
Chiavi di servizio /  
Tubetto di grasso / Libro istruzioni

Vai alla pagina  
di catalogo per  
approfondire



Ratio  
1:8



Rpm  
24.000  
output  
3.000  
input



Kw 8



Nm 9,5



ISO / BT 40  
Kg 6  
ISO / BT 50  
Kg 8,5



Ø 13



ER20  
Ø1/13



N 413

### EVOLUTION LINE

# GSP 13

Prezzo Listino ~~€ 3.252~~  
Prezzo Speciale: **€ 3.000**



## CONI INTERCAMBIABILI

Coni intercambiabili per un utilizzo  
su più centri di lavoro.  
Una sola testa per più centri di lavoro

## CORPO TESTA IN ACCIAIO

Corpo testa orientabile a 360° con pressu-  
rizzazione interna. In acciaio trattato, mas-  
sima rigidità e resistenza alla corrosione

## ANCORA PIÙ VELOCI

Velocità aumentata  
oltre il 30%  
sull'intera gamma

## REFRIGERAZIONE INTERNA

disponibile la refrigerazione interna su  
tutta la gamma con pressione  
fino a 70bar